

Stotal = 14 m² H= 1 m

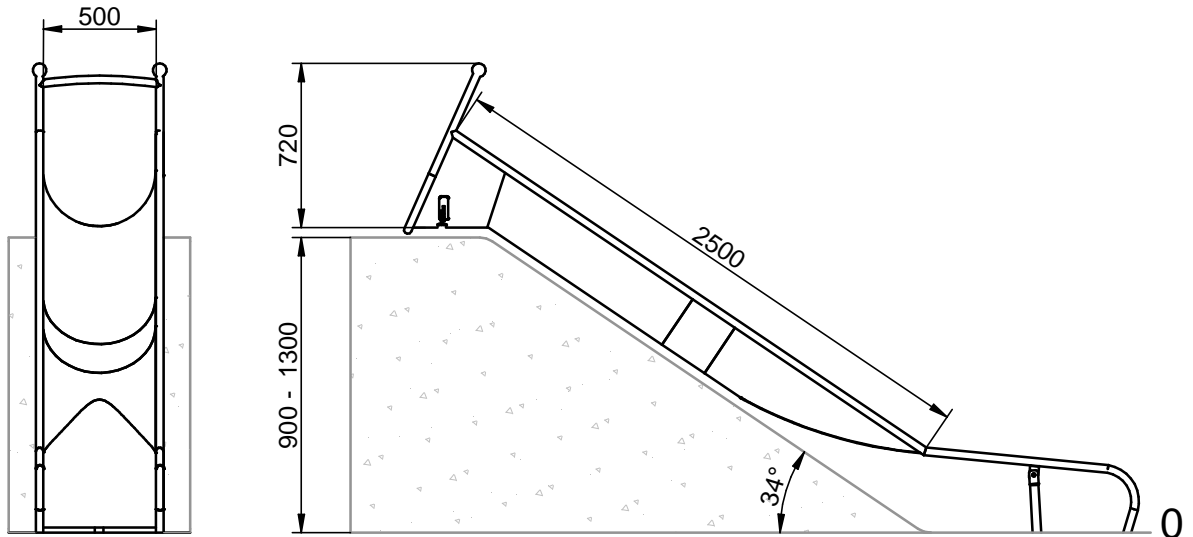

Stotal = 18 m² H= 1 m

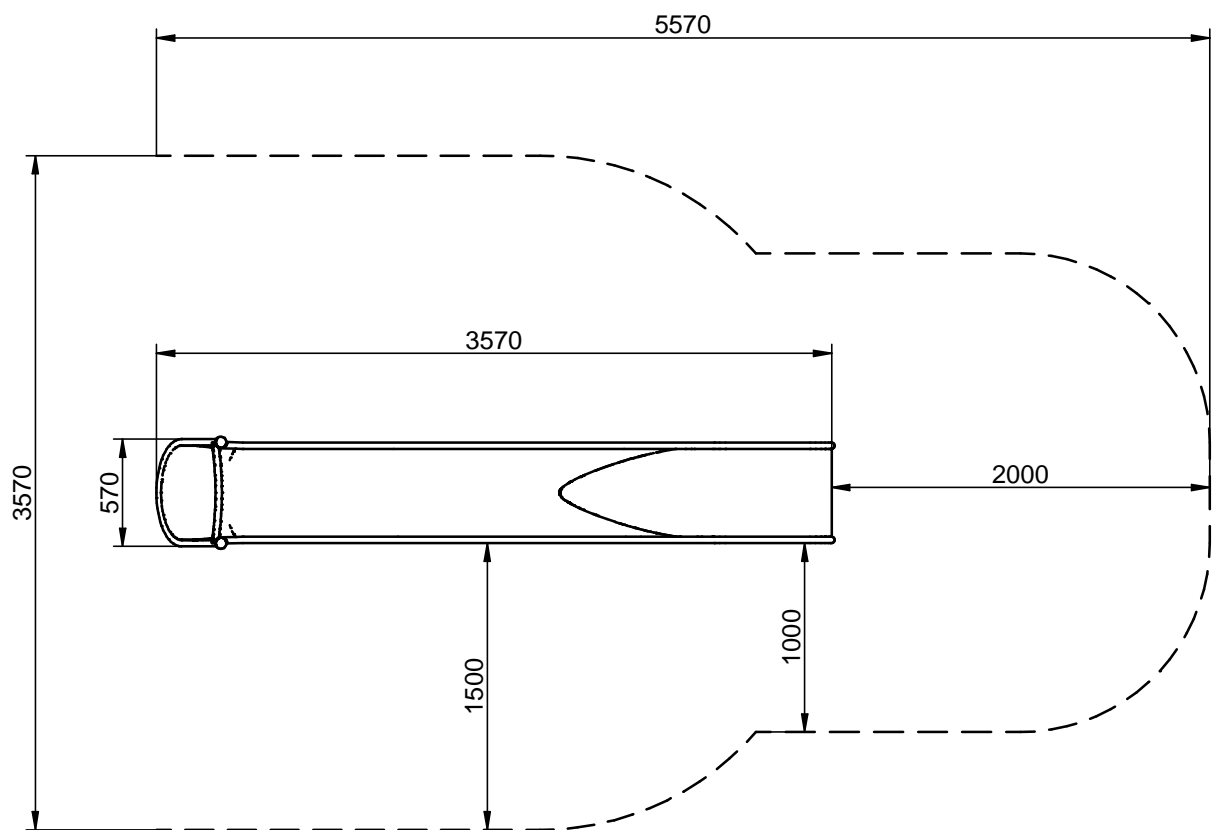
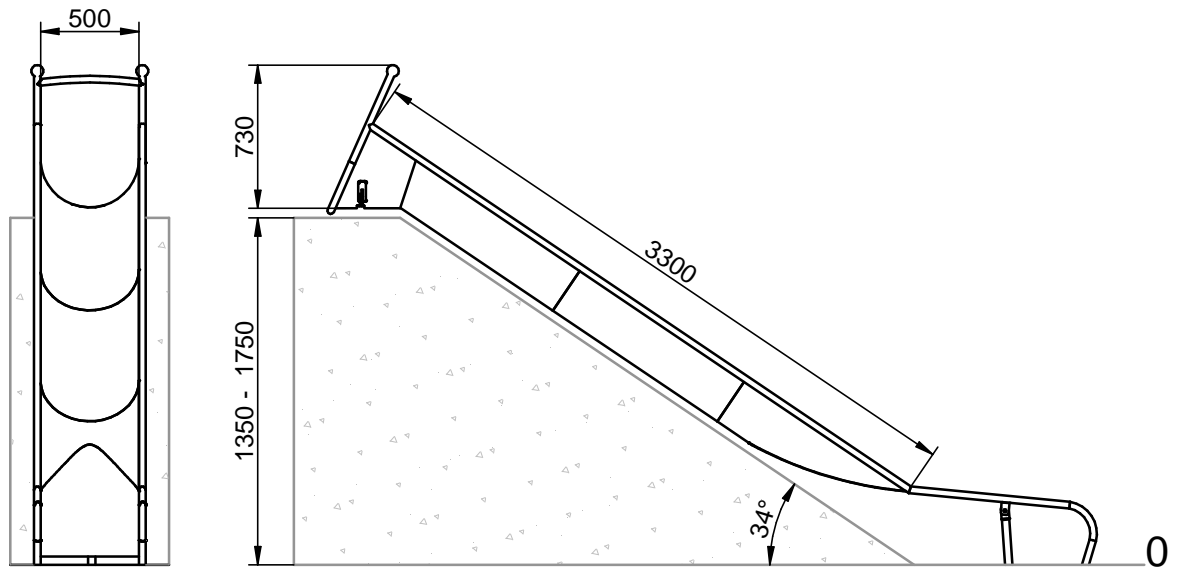

Stotal = 20 m² H= 1 m

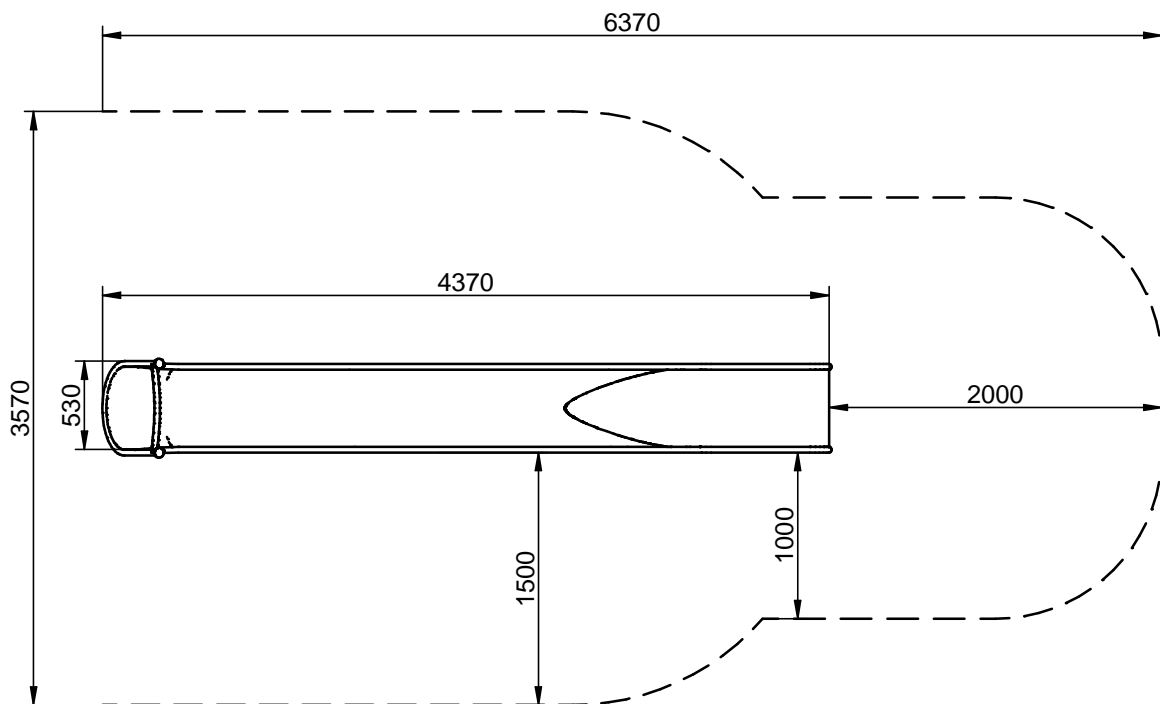
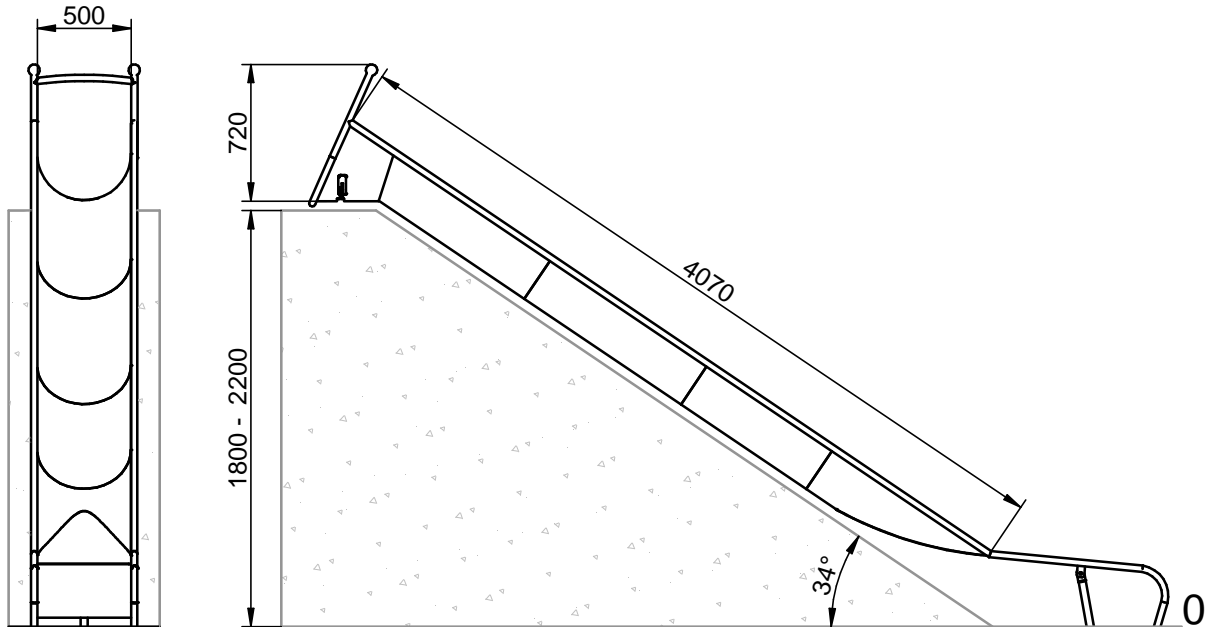

Stotal = 23 m² H= 1 m

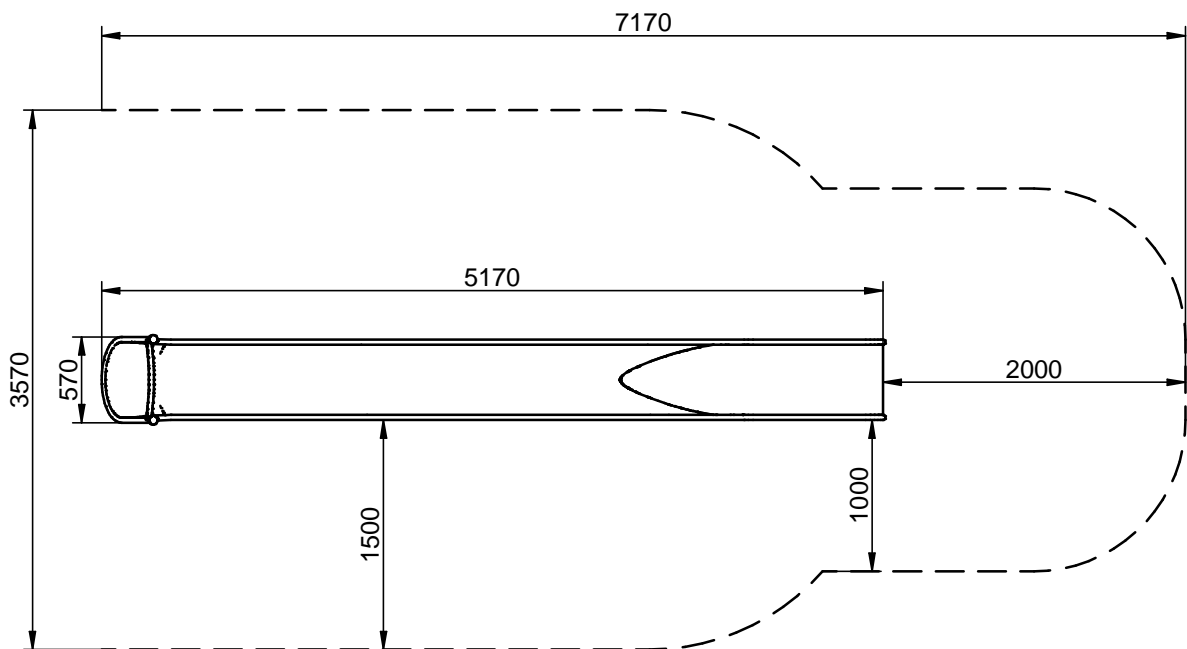
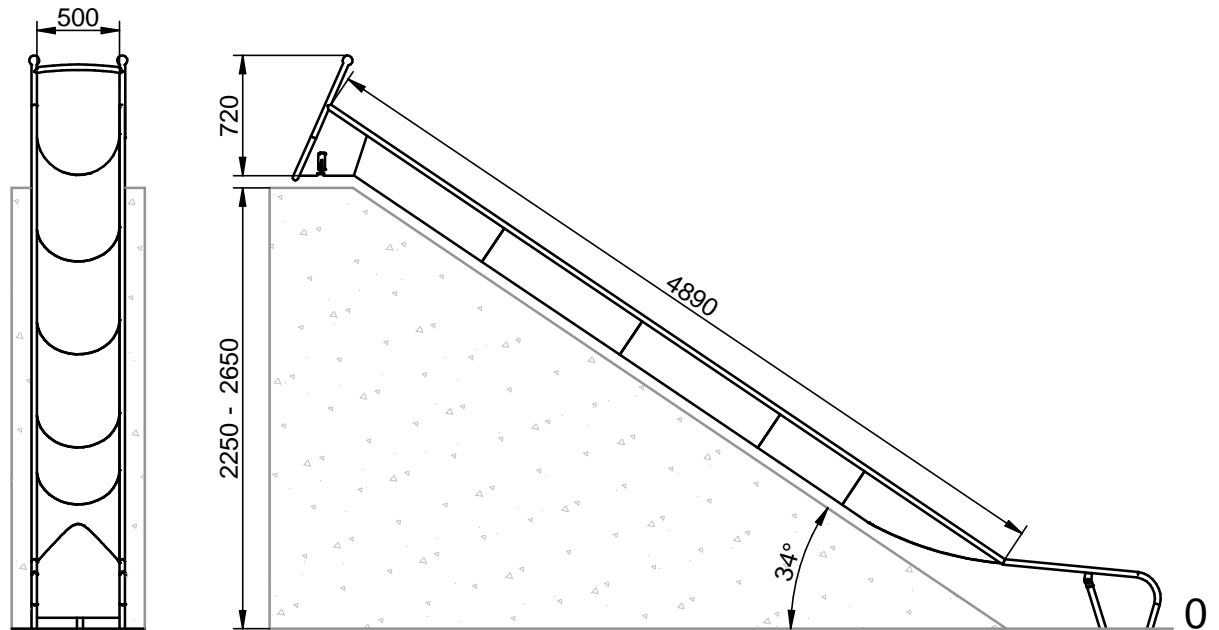

Stotal = 26 m² H= 1 m

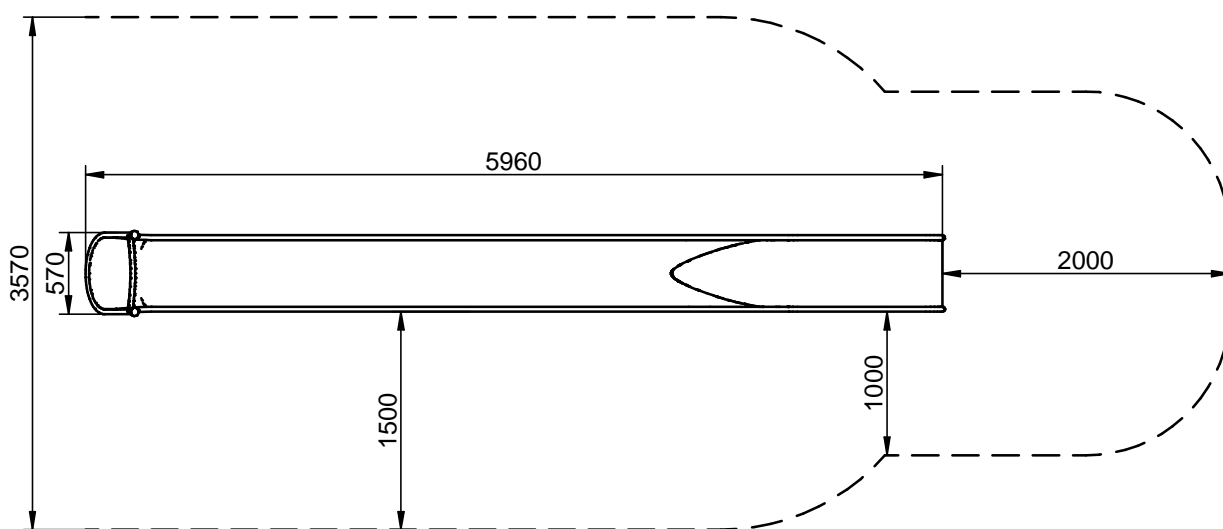
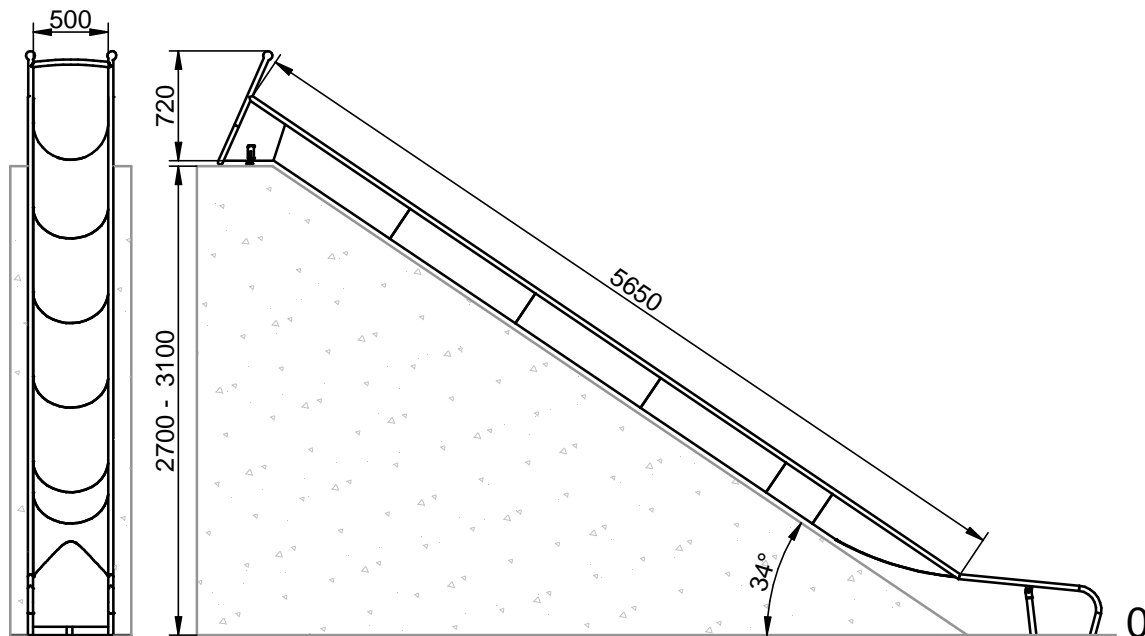

Stotal = 29 m² H= 1 m